

**East Ogden Avenue
Naperville**

Monument Sign Standards

February 12, 2018

315 W. Spring Avenue,
Naperville, IL 60540
630.548.1315
EXHIBIT A
www.kpetersonandassociates.com

East Ogden Avenue Naperville

Monument Sign Standards

Design Challenges

- 1. Create a distinctive and consistent theme to establish a unique character to the East Ogden Avenue Commercial Corridor**
- 2. Because of the variety of building types and architecture, the new standards should neither be ultra "Traditional" nor "Contemporary" in their style.**
- 3. Create standardization of materials, yet, allow for individual architectural project coordination on a case by case basis.**

Proposed Design Consistencies

- 1. Create a standard character, proportion and use of design elements, limestone caps and Planters**
- 2. A consistent Brushed Metal signage frame.**
- 3. A consistent Brushed Metal Address number and location**

Proposed Design Variables

- 1. Overall Size based on the Sign Ordinance**
- 2. The Brick or Stone selection from the Standards or a possible project coordinated Masonry approved on a case by case basis for architectural design flexibility.**

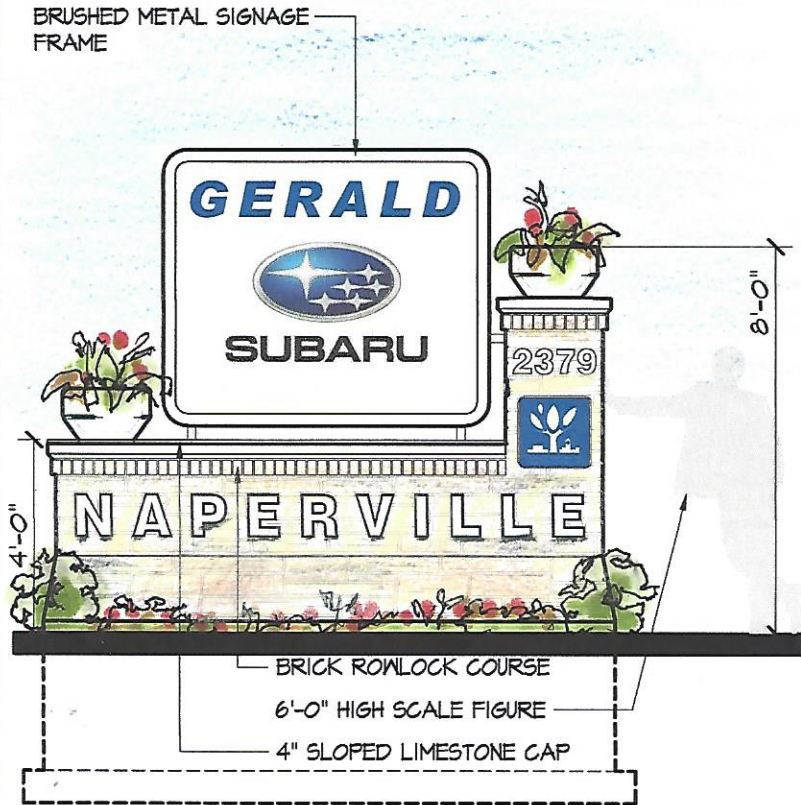

PROPOSED
FRONT ELEVATION

SCALE: 1/4" = 1'-0"

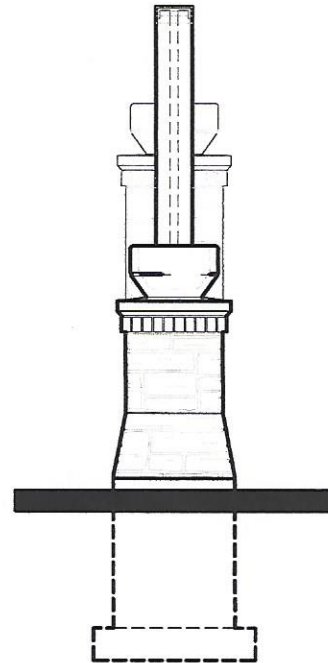

PROPOSED
SIDE ELEVATION

SCALE: 1/4" = 1'-0"

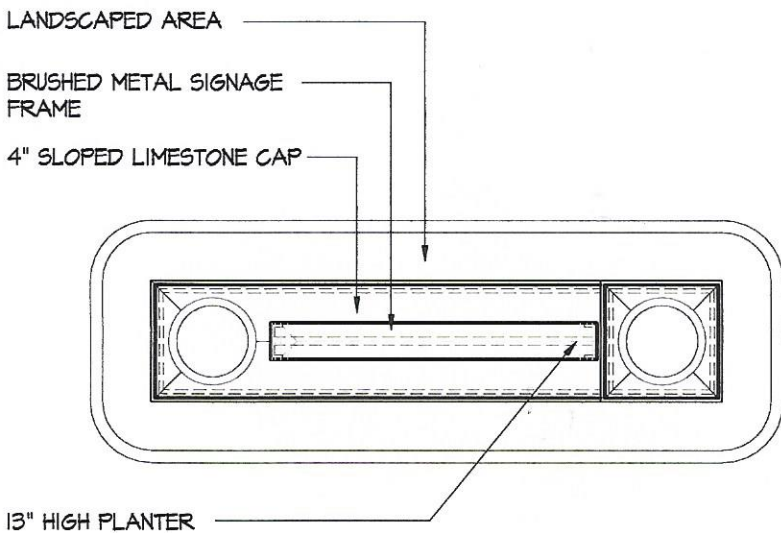

PROPOSED SIGN
PLAN - CORNER VERSION

SCALE: 1/4" = 1'-0"

SK 4.1



Sheet

1 of 4

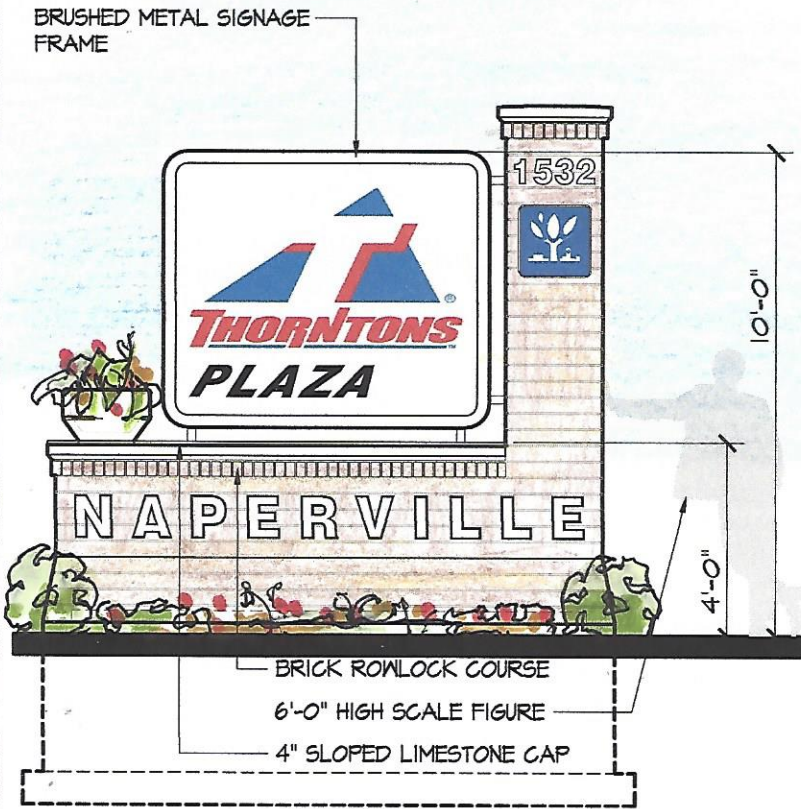

PROPOSED
FRONT ELEVATION
SCALE: 1/4" = 1'-0"

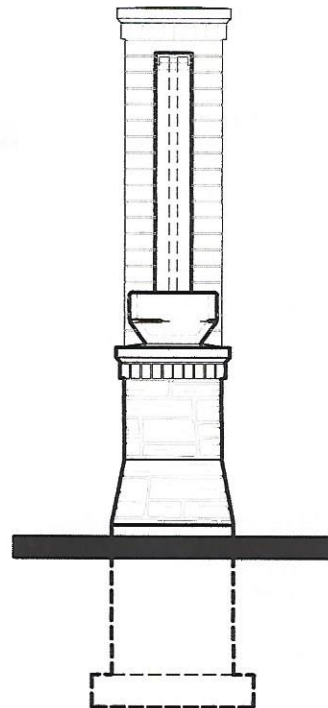

PROPOSED
SIDE ELEVATION
SCALE: 1/4" = 1'-0"

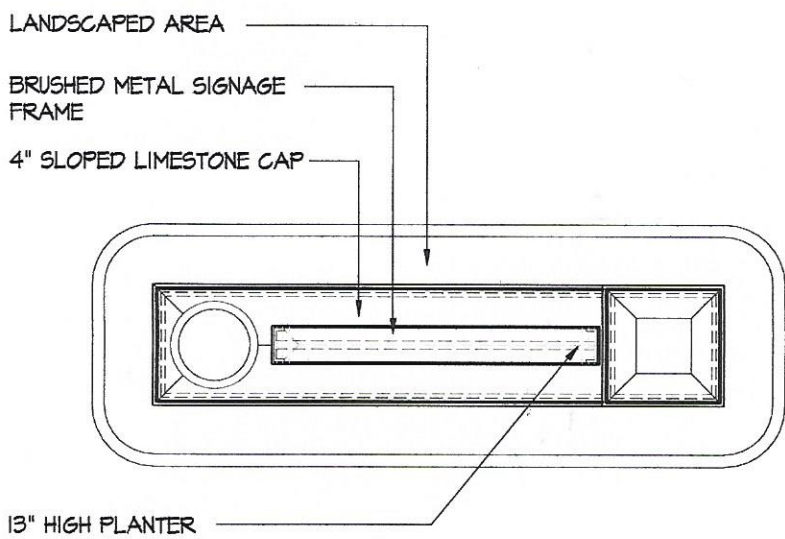

PROPOSED SIGN
PLAN - CORNER VERSION
SCALE: 1/4" = 1'-0"

SK 4.2

K. PETERSON
ASSOCIATES
ARCHITECTS

315 SPRING AVENUE
NAPERVILLE, ILLINOIS 60540
PH. 630.548.1315

STANDARD SIGNAGE VERSION

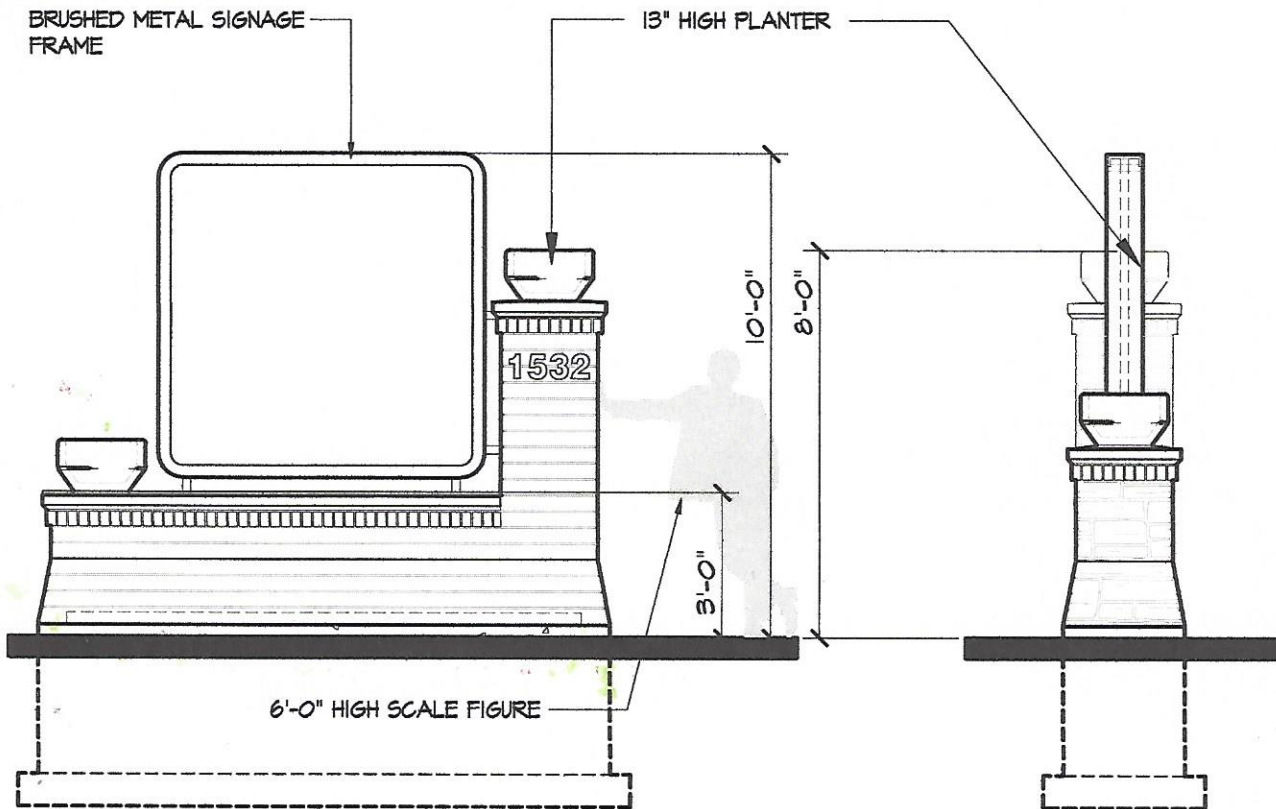

PROPOSED
FRONT ELEVATION

SCALE: 1/4" = 1'-0"

PROPOSED
SIDE ELEVATION

SCALE: 1/4" = 1'-0"

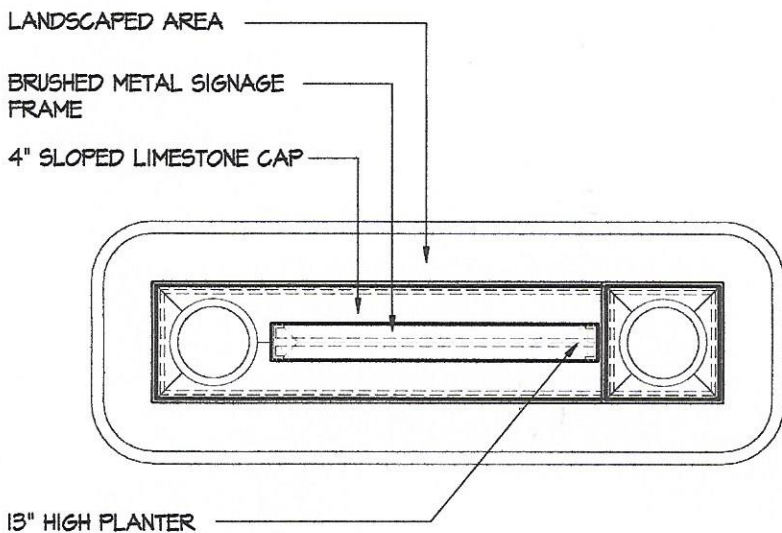

PROPOSED SIGN
PLAN - CORNER VERSION

SCALE: 1/4" = 1'-0"

SK 4.3

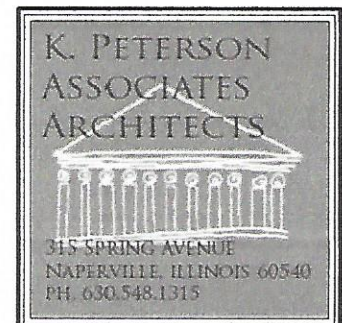

Sheet

3 of 4

STANDARD SIGNAGE VERSION

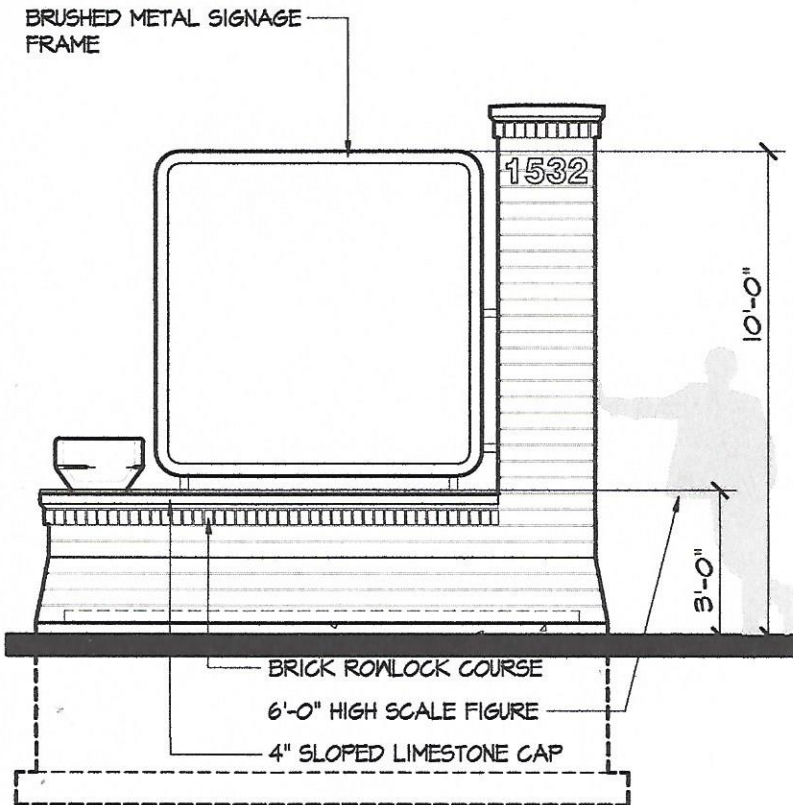

PROPOSED
FRONT ELEVATION

SCALE: 1/4" = 1'-0"

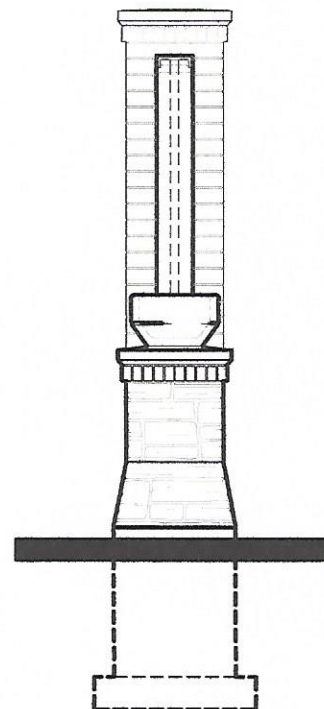

PROPOSED
SIDE ELEVATION

SCALE: 1/4" = 1'-0"

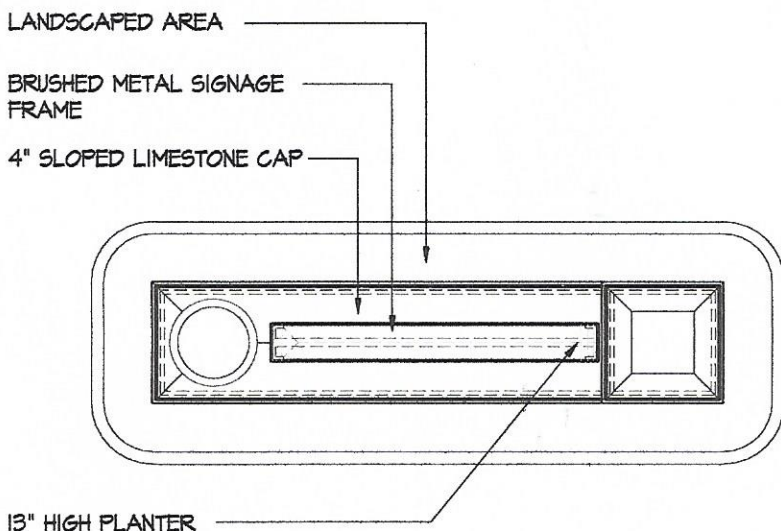

PROPOSED SIGN
PLAN - CORNER VERSION

SCALE: 1/4" = 1'-0"

SK 4.4

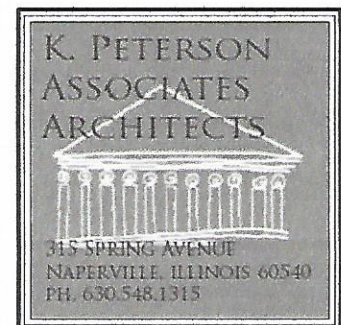

Sheet

4 of 4

Create the Standard Masonry



BROWN

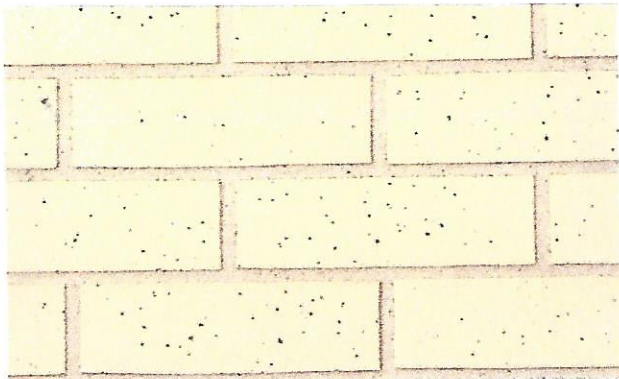

CREAM



BUFF



LIMESTONE